

SECURITRON MODEL UNL-12, UNL-24 UNLATCH INSTALLATION AND OPERATING INSTRUCTIONS

1. DESCRIPTION

Securiton's UnLatch is a revolutionary new type of electric strike which **eliminates the necessity to perform a routing operation on the door frame for installation**. The **motor driven UnLatch** also presents a **fully concealed appearance** on the door which not only enhances the architectural appeal of the installation but **improves security** over a conventional electric strike as an intruder is less able to determine the type of security device present on the door. The UnLatch **functions with cylindrical dead latches or spring latches** and includes a **latch status output** which reports when the door is in latched (secure) condition or is open.

Product Specifications are: **Input Voltages:** 12 VDC (UNL-12), +20%, -10%. 24 VDC (UNL-24), +20%, -10%. **Current:** At rest: 40 mA (either voltage). When operating- 3 Amp input surge @ 12 VDC; 1.5 Amp input surge @24 VDC for 100 milliseconds and 300 mA @ 12 VDC or 200 mA @ 24 VDC thereafter. **Operating Temperature:** -10° F to 125° F.

FIG 1: UNLATCH DIMENSIONS (INCHES)

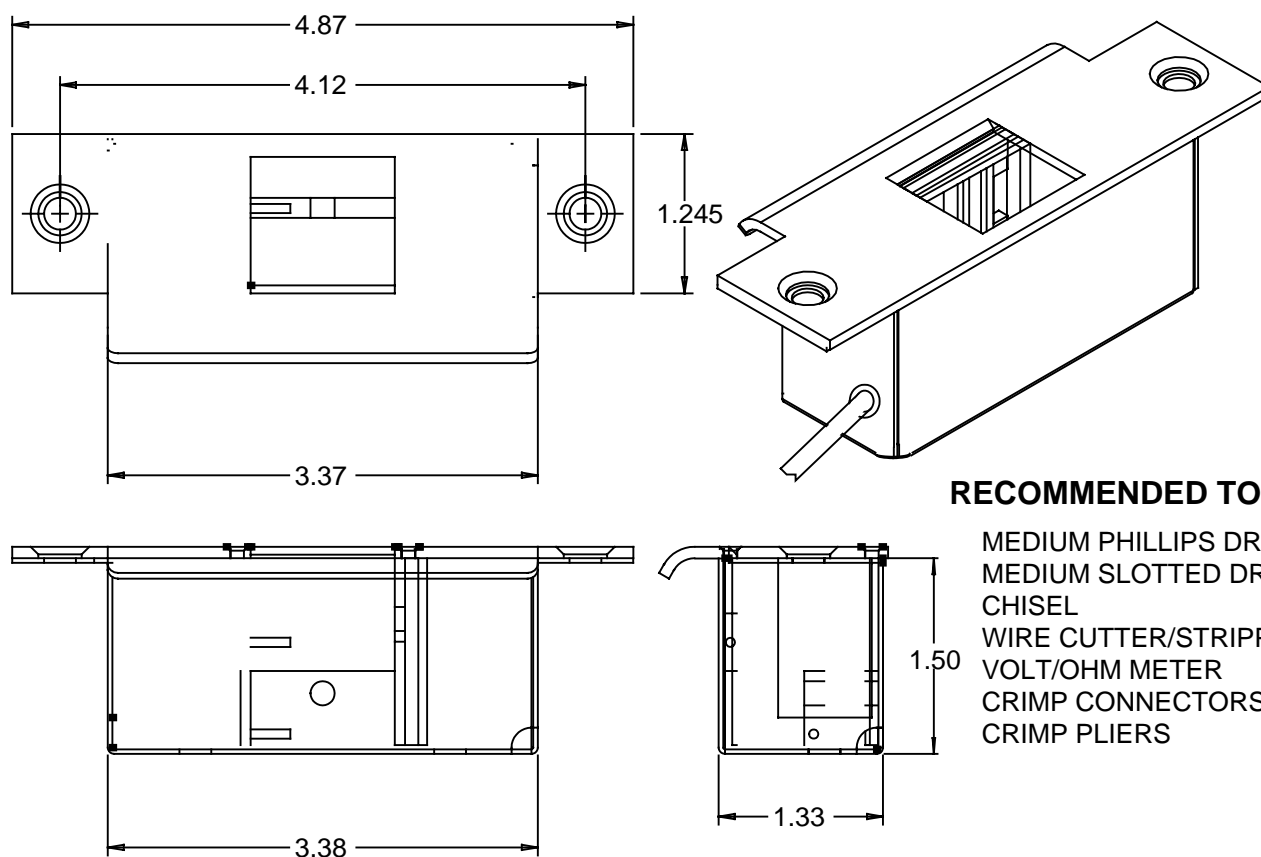

RECOMMENDED TOOLS

- MEDIUM PHILLIPS DRIVER
- MEDIUM SLOTTED DRIVER
- CHISEL
- WIRE CUTTER/STRIPPER
- VOLT/OHM METER
- CRIMP CONNECTORS
- CRIMP PLIERS

2. PHYSICAL INSTALLATION

2.1 SURVEY

The installer must first be sure that the **latch is of the cylindrical type** with or without the deadlatch function. See Figure 2. Most North American latches are of this type which is also called tubular. Examples of **latch types on which the UnLatch will not function** include many panic bar latches and rim latches (rim latches are on the surface of the door rather than being mortised into the middle of the door). The UnLatch also will not function on mortise latches. These are heavy duty rectangular units similar in appearance to the drawing on the right. After determining that there is a cylindrical latch, the installer must determine whether there is a wooden, or hollow metal (steel) door frame and whether the type of strike

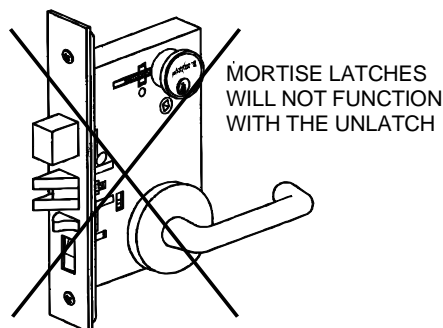

present on the frame is of the ANSI 2 3/4" type (found on many residential doors) or the ANSI 4 7/8" strike (commercial).

FIG. 2: IDENTIFICATION OF CYLINDRICAL DEADLATCH AND SPRINGLATCH

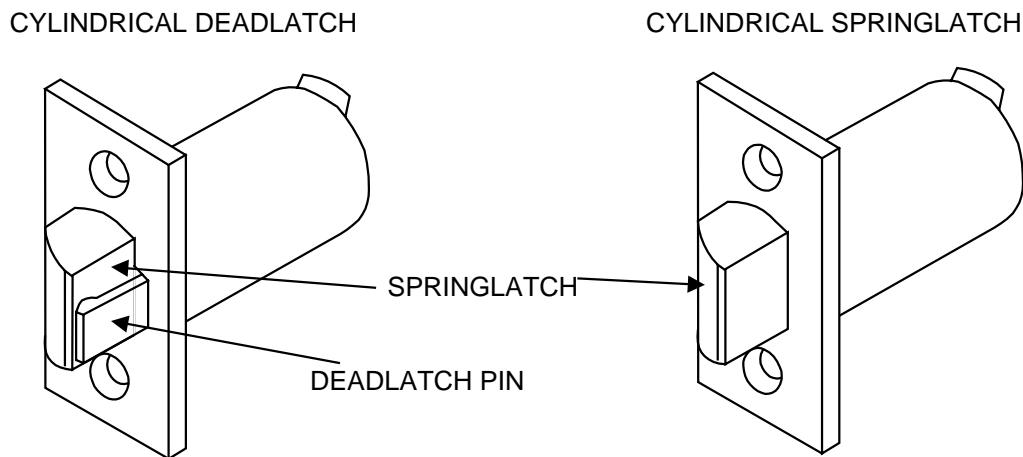

2.2 HOLLOW METAL (STEEL) FRAME MOUNTING

Most steel door frames include a **4 7/8" ANSI strike**. This type of door preparation allows simple installation of the UnLatch. Remove the existing strike plate (it will be discarded) and experimentally try to fit the UnLatch in the resulting cavity. In some cases the cavity will be large enough to accommodate the UnLatch and you will have nothing to do but pull the wires up the hollow door frame and screw the UnLatch into place. In other cases you will find a "dust box" within the frame that will get in the way of the UnLatch. The dust box must be cleared away to make room for the UnLatch. Generally a sabre saw or a drill with a fly cutting bit is the most effective tool to do this. You can also find that the edge of the dry wall panel interferes with the UnLatch. Simply chip away some of the dry wall with a screwdriver to make room. Once you are able to fit the UnLatch into the frame, **vacuum out any concrete dust and metal shavings** (these can work their way into the UnLatch mechanism and cause problems).

If the hollow metal frame has a **2 3/4" strike**, installation of the UnLatch is still possible but it is much more difficult. You will have to route out a larger strike plate recess to convert the door preparation to 4 7/8 ANSI and this includes setting mounting tabs within the frame. Generally, commercial locksmiths have the skills to perform this work.

2.3 WOOD FRAME MOUNTING

Installation in a wood frame is straightforward. It is a question of using a chisel to create a space for the UnLatch behind the existing strike. The procedure depends on whether you have a 4 7/8" ANSI strike (commercial) or a 2 3/4" ANSI strike (residential) on the door. **In the case of a 4 7/8" ANSI strike**, you will be using the existing holes that mount the strike to mount the UnLatch. Remove the strike and place the template on the door (registering it to the strike mounting holes). This will show you the space that must be chiseled out. As you get close to finishing the chiseling job, experimentally try to fit the body of the UnLatch in the cavity. This will avoid chiseling too big a space. **A tight fit is preferred** as it helps the solidity of the mounting which is important if the door receives abuse. Normally, with a wood frame, the wires will be run inside the wall. Simply drill from the back of the cavity you have created rearward into the wall space to admit the wires into the walls. To mount the UnLatch to the wood frame, use the two #12 x 1" flat head wood screws which have been furnished. Once you are able to fit the UnLatch into the frame, **vacuum out any concrete dust and metal shavings** (these can work their way into the UnLatch mechanism and cause problems)

In the case of a 2 3/4" ANSI strike, you will be using two new holes which are separated more widely to mount the UnLatch. You will also have to perform two chiseling operations. You will have to chisel a deep cavity for the body of the UnLatch and a shallow relief (3/32" or 2 MM deep) to fit the UnLatch's face plate flush with the frame surface. A **template** (see page 9 of this manual) is provided to guide this chiseling but some work needs to be done to register the template to the frame:

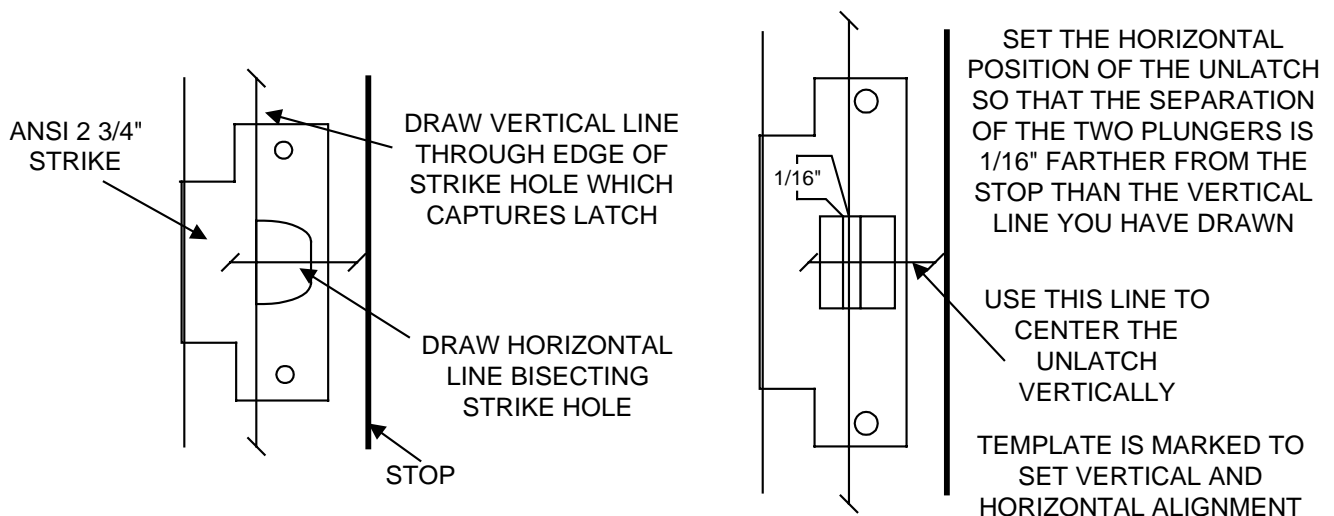
FIG. 3: MOUNTING ON WOOD DOOR WITH ANSI 2 3/4" STRIKE

First, draw two lines with a pencil on the door frame (see Figure 3).

The first line is **horizontal and bisects the 2 3/4" ANSI strike**. The second is **vertical and extends the edge of the strike opening** which captures the latch. Next, remove the strike and introduce the template. Note that the **template shows a center line arrow** which you will use to position the UnLatch vertically by lining it up with the center line you have previously drawn. Next, the **template has arrows at the top and bottom** which line up with the vertical extension line you have drawn. These arrows position the UnLatch horizontally so that the separation between the two UnLatch plungers is 1/16" farther from the stop than the edge of the ANSI 2 3/4" strike. The latch is captured by the UnLatch at the separation line between the plungers and moving this position somewhat away from the stop increases adjustability of the installation.

When you have the template correctly positioned, mark your top and bottom mounting holes. Then you will need to chisel out a shallow space 3/32" (2MM) under the complete outline of the UnLatch and chisel a rectangular cut-out as the template shows, 1 3/4" (44.5MM) deep to admit the UnLatch body. As you get close to finishing the chiseling job, experimentally try to fit the UnLatch body in the cavity. This will avoid chiseling too big a space. **A tight fit is preferred** as it helps the solidity of the mounting which is important if the door receives abuse. Normally, with a wood frame, the wires will be run inside the wall. Simply drill from the back of the cavity you have created rearward into the wall space to admit the wires into the walls. To mount the UnLatch to the wood frame, use the two furnished #12 x 1" flat head wood screws.

Note finally that we have implied that there are only two types of strikes on wooden doors: the ANSI 4 7/8" and the ANSI 2 3/4". In residential applications there are also square shaped strikes (particularly found with inexpensive imported latches) which are smaller in outer dimensions than the 2 3/4" strike. These pose no difficulties. The installation techniques are the same as for an ANSI 2 3/4" strike.

2.4 FINAL ADJUSTMENT WITH SPACERS

For reliable operation, the door needs to close so that the latch easily enters and is retained by the UnLatch. The door should not have to be pushed to engage as can be the case with a poorly fitting or poorly closing door. To check this point, when the UnLatch has been mounted, after the door is closed and latched, you should be able to "rattle" the latch against the UnLatch plunger by pushing the door in and out. **The amount of movement in the door latch should be about 1/16-1/8" (1.5-3MM).**

If the amount of slack or rattling is greater than 1/16-1/8", you need the door to "**close earlier**". In effect, the edge of the stop needs to be closer to the UnLatch. To adjust for this, first check to see if the stop has "**silencers**". These are cylindrical rubber bumpers which quiet the noise of a closing door but also have the effect of making the door close earlier. If you have silencers and the door is still rattling too much, contact the factory for additional door stop spacers (the UnLatch is shipped with two). If you don't have silencers, add one or two door stop spacers as is shown in Figure 4 to cause the door to close earlier.

If the amount of slack or rattling is less than 1/16-1/8", you have a "tight" door and the ability of the door to close and latch reliably is in question. To adjust for this, first check to see if the stop has "silencers" on it. These are cylindrical rubber bumpers which quiet the noise of a closing door but also have the effect of making the door close earlier. Remove the silencers (they pull out) and this will add slack to the closed position of the door. Be sure to check the entire length of the door for the silencers. If the door has no silencers and is still tight in latching, a locksmith should be engaged to readjust the door so that it closes properly or the installation will not be reliable.

Note that Figure 4 illustrates the points made in this Section.

FIG. 4: FINAL ADJUSTMENT OF DOOR CLOSING TOLERANCE

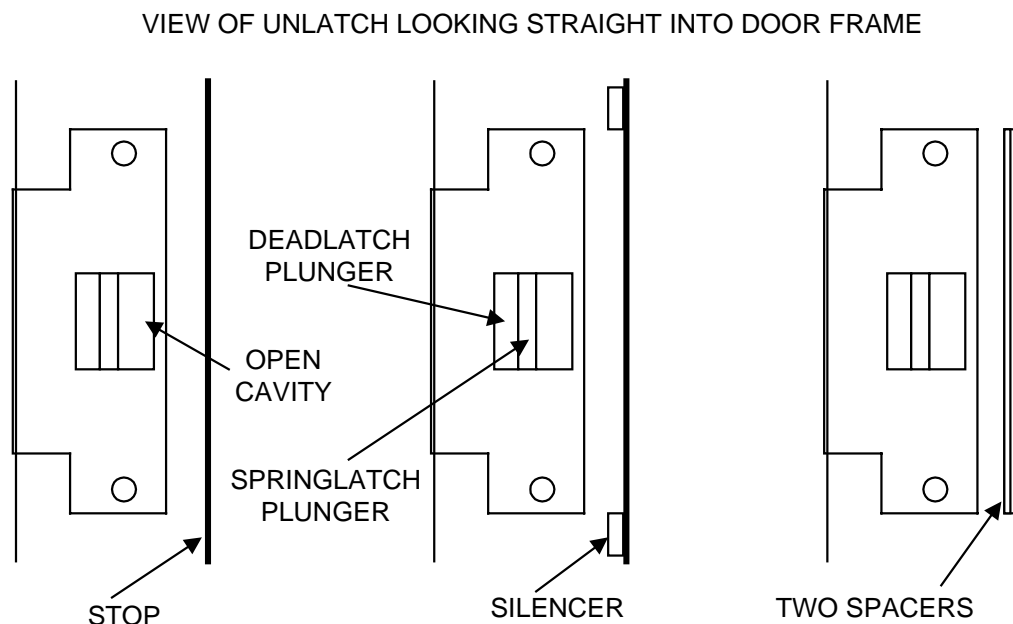

3. OPERATION

While you can make a successful installation without knowing how the UnLatch functions, it's best if you understand its operation in the event you run into any difficulties or questions. The operation of the UnLatch is, of course, intimately connected with the way latches and specifically deadlatches work on a door so we'll cover this first.

An ordinary latch is called a **springlatch** and it's used on low security interior doors. One of the reasons that this latch's security is low is that an intruder can retract the latch and open the door from the outside by slipping something flexible like a credit card in between the door and frame. To forestall this, the **deadlatch** was created. The deadlatch includes a **deadlatch pin** which is depressed against the flat part of the strike when the door is closed. When the deadlatch pin is depressed, the latch cannot be pushed in (by a credit card for instance); it is mechanically blocked. Deadlatches therefore offer a considerably higher level of security and this level of security is usually desired on doors subject to electric control from the installation of the UnLatch or other electric strike. The UnLatch makes full use of the deadlatch pin and preserves its security function. Springlatches however can also be employed with the UnLatch.

Note that the UnLatch has two rectangular plungers which move under the control of a motor. We call these the **springlatch plunger and deadlatch plunger**. When the door is in the closed and secure position, the springlatch pushes in the springlatch plunger and the deadlatch pin rests on the deadlatch plunger which pushes in the deadlatch pin. This maintains the latch in the secure position and makes full use of the deadlatching function.

When the UnLatch operates (the trigger wire connects to the +V wire), the deadlatch plunger retracts into the body of the UnLatch which allows the deadlatch pin to move out. Then both plungers simultaneously push the latch and deadlatch pin back into the latch body and the door may be opened from the outside. This operation takes about 1/3 of a second. When the trigger wire is removed from the +V wire, the UnLatch will return to its initial condition: the springlatch plunger will retract into the UnLatch body which allows the latch to resecure the door and the

deadlatch plunger will push out depressing the deadlatch pin and freezing the latch for best security.

FIG 5: UNLATCH VIEW FROM ABOVE IN REST (SECURE) POSITION

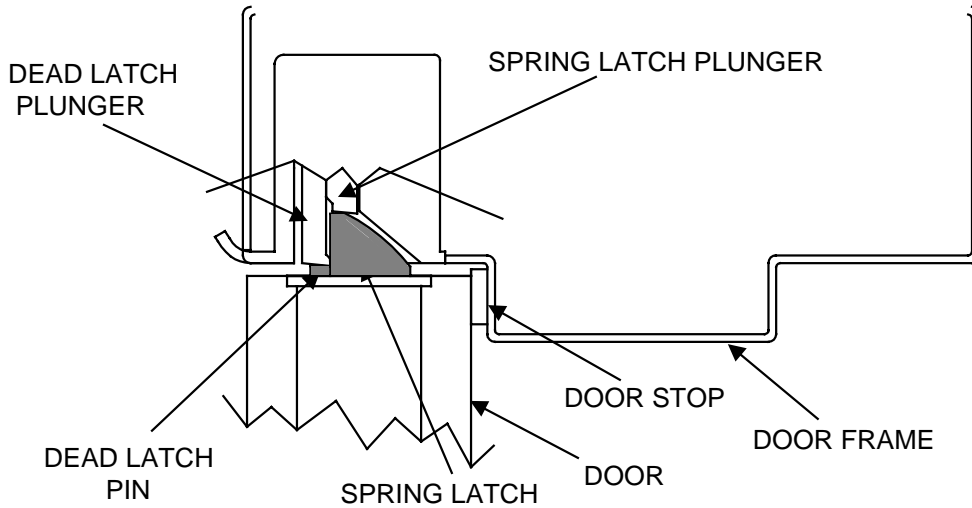

IN THE REST (SECURE) POSITION, THE SPRING LATCH IS ALLOWED TO COME OUT BY THE SPRING LATCH PLUNGER THEREBY SECURING THE DOOR. THE DEAD LATCH PLUNGER HOWEVER PUSHES IN THE DEAD LATCH PIN WHICH "FREEZES" THE SPRING LATCH FOR BEST SECURITY.

FIG 6: UNLATCH IN OPERATION

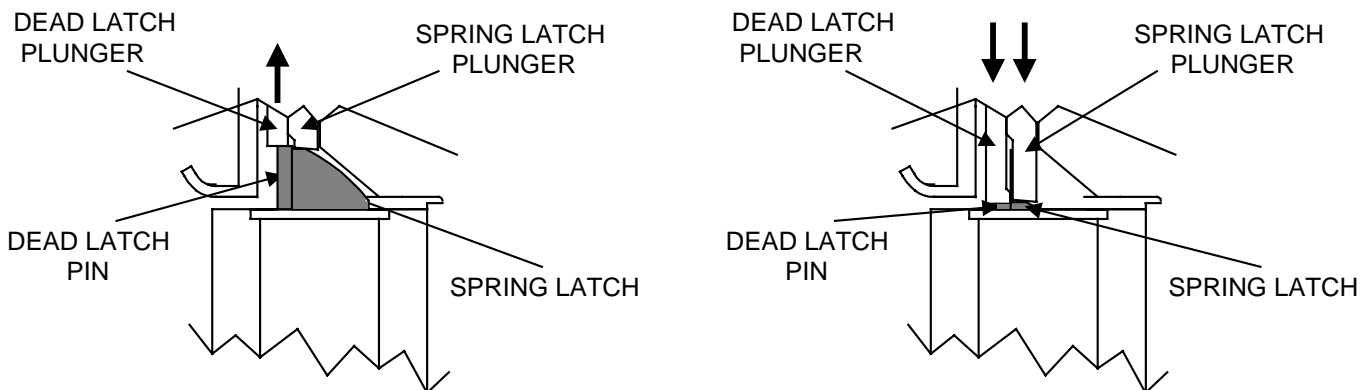

IN THE FIRST OPERATIONAL STEP, THE DEAD LATCH PLUNGER WITHDRAWS WHICH ALLOWS THE DEAD LATCH PIN TO COME OUT. THIS "UNFREEZES" THE SPRING LATCH

FINALLY, BOTH PLUNGERS MOVE FORWARD TOGETHER. THIS PUSHES OUT THE SPRING LATCH AND DEAD LATCH PIN AND THEREBY RELEASES THE DOOR.

Note that if the door is heavily pre-loaded (by someone trying to pull it open before the UnLatch has released it for example), the UnLatch may not possess enough power to release the door. This is termed a **stall condition** for the motor. When a motor is stalled for a period of time, it can be damaged by heat build up as motors draw heavy current when they're not permitted to move. The **UnLatch automatically detects any stall condition** that persists for more than 1.5 seconds and shuts itself off. To operate, the UnLatch must simply be triggered again (which is the normal action for anyone who has failed to enter) and it will operate normally.

4. WIRING

4.1 GENERAL ELECTRICAL CHARACTERISTICS

The UnLatch is a six wire device. Power (12 or 24VDC depending on the model) is applied to the red and black wires observing polarity and **power should be continuously present on these wires. If you connect power in reverse, the UnLatch will not operate but it will be damaged if left connected for an extended period of time.** To operate the UnLatch, the **trigger wire (orange)** should be connected to the **red wire (+V)** via an external switch. When this connection is made, the UnLatch will release the door and keep it released so long as the red and orange wires are connected. When connection between these wires is broken, the door will be resecured (once it recloses). In certain applications the door is released all day and secured all night. There is no problem operating the UnLatch in this manner (continuous duty) but it is more common for the door to be released for only a few seconds at a time for controlled entry. This is typically done by connecting the orange and red wires together from relay contacts which close from an external card reader, digital keypad or keyswitch. The external control device includes a timing function which will operate the UnLatch for a few seconds to permit each entry. Like most conventional electric strikes, the UnLatch is **fail secure** which means that it will maintain the door in a secure position if power is lost. Entry is not possible but people can, of course, exit by simply turning the door handle or knob from the inside.

FIG. 5: UNLATCH WIRING

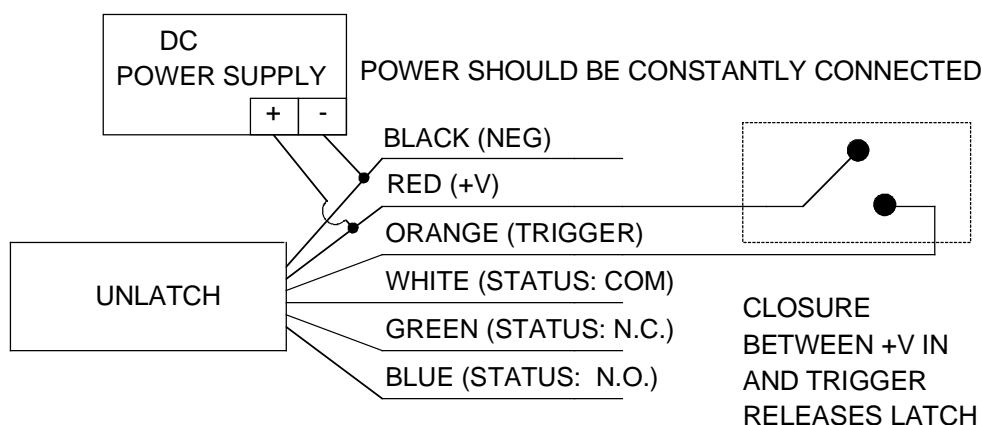

In normal operation, the UnLatch draws about 300 mA @ 12 VDC or 200 mA @ 24VDC when it operates (the motor is moving) and a steady 40 mA at all times. Note that regulated input voltage is not required to operate the UnLatch. **Full wave rectified DC is acceptable** (transformer + bridge rectifier). **Power supply capacity**, however, is ideally 3 Amps @ 12 VDC or 1.5 Amps @ 24 VDC for best operation. This is because the UnLatch's motor (like all motors) will momentarily draw a lot more current if it has to "work harder". This occurs for a very short time at motor start. If power supply capacity is limited, the UnLatch will still operate but it will operate a bit more slowly. The same condition of high current draw will occur for a longer period of time if the latch is binding which could be a permanent condition of the latch or could be because the person trying to enter is pulling on the door. Again, the UnLatch will function but more slowly and weakly. If a full capacity power supply is not practical, a 1 Amp power supply which includes battery backup such as Securitron's model BPS-12-1 or BPS-24-1 is an equally effective device to power the UnLatch as the battery will provide the extra surge current as it is needed. Another point to note is that when one relatively large power supply is serving a number of UnLatches, the extra current capability will always be there as each UnLatch will operate at different times so each can draw extra current from the power supply when needed.

If you are using a smaller capacity power source, you may well be satisfied with the operation of the UnLatch since the reduction in torque is only really noticeable when the door is pre-loaded. There is, however, an important electronic effect. During the brief moment (100 milliseconds) while the motor is starting to move, the UnLatch will "try" to draw 3 or 1.5 Amps (depending on the voltage). A power supply of lower capacity will react to this condition by sharply dropping its voltage for the same brief period. While this will not harm the power supply, it may "crash" microprocessor equipped devices like digital keypads (such as Securitron's model DK-11 or DK-26) that are being **operated from the same power supply**. If, therefore, your

installation includes a digital keypad, or other microprocessor equipped device, make sure you have full power supply capacity or use a separate power supply for the keypad or other device.

4.2 WIRE GAUGE SIZING

If the power supply is **some distance from the lock, voltage will be lost (dropped)** in the connecting wires so that the UnLatch will not receive full voltage. The amount of voltage that is dropped in the wires depends on the resistance of the “round trip” wire run compared to the resistance of the UnLatch. The issue is complicated by the fact that the resistance of the UnLatch is 35 Ohms @ 12 VDC or 120 Ohms @ 24 VDC when it is operating (the motor is moving) but the resistance drops as low as 4 Ohms @ 12 VDC or 16 Ohms @ 24 VDC for 100 milliseconds just as the motor starts. If the unit is denied full voltage during this motor start period, it will operate but with less torque so it will not release the latch as crisply when the latch has pre-load on it. **Selecting thick wires to power the UnLatch will maintain strong torque even during start up.** The following table shows distances from the UnLatch to the power source and calls out the wire gauge needed to **fully** maintain torque. Note that if your installation requires the power source to be more distant or has other complications, the factory can assist you.

Distance (one way)	50 ft. (15 M)	100 ft. (30 M)	200 ft. (60 M)
Wire Gauge for UNL-12	16	14	12
Wire Gauge for UNL-24	22	20	18

4.3 LATCH STATUS SENSING

The UnLatch includes a latch status sensing feature. When the door is closed and the door latch has engaged the UnLatch (specifically the spring latch plunger has been pushed in by the door latch), the UnLatch will **report this secure condition** by outputting a closed circuit condition between the white (COM) and green wires (see the drawing to the right). When the **door is not securely latched**, the closure will be between the white and blue wires. This dry SPDT output can carry **1 Amp @ 30 VDC maximum**. This signal is normally connected to the building alarm system and it provides superior information compared to conventional door contacts which show only that the door is closed, not whether it is latched. Note that the UnLatch’s ability to report on the latched status of the door **depends on it receiving constant power**. Any time power is cut to the UnLatch, it will report the door as secure regardless of whether it is latched or not.

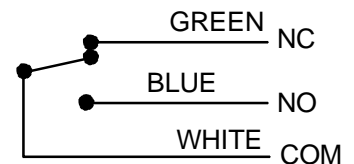

The UnLatch uses the information as to whether the door is latched or not for a second purpose. The **UnLatch will not operate unless the latch is in the secure position** (the spring latch plunger is pushed in). The reason for this is to avoid a potential jam condition. If the door had not fully closed, the spring latch could be adjacent to the dead latch plunger and the dead latch pin would be resting on the metal “strike” casing of the UnLatch. In this condition, if the UnLatch was allowed to operate, the dead latch plunger would attempt to push the spring latch and it would be unable to do so because the dead latch pin would be pushed in by the metal casing of the UnLatch. The motor would jam. The UnLatch senses any motor jam condition and shuts itself down for that cycle but it is better not to operate at all unless the door is latched. Operationally, the door can be opened anyway (it is not latched) so there is no benefit to the end user from the UnLatch operating unless the door is latched.

MAGNACARE LIMITED LIFETIME WARRANTY

SECURITRON MAGNALOCK CORPORATION warrants that it will replace at customer's request, at any time for any reason, products manufactured and branded by SECURITRON.

SECURITRON will use its best efforts to ship a replacement product by next day air freight at no cost to the customer within 24 hours of SECURITRON's receipt of the product from customer. If the customer has an account with SECURITRON or a valid credit card, the customer may order an advance replacement product, whereby SECURITRON will charge the customer's account for the price of the product plus next day air freight, and will credit back to the customer the full amount of the charge, including outbound freight, upon SECURITRON's receipt of the original product from the customer.

SECURITRON's sole and exclusive liability, and customer's sole remedy, is limited to the replacement of the SECURITRON product when delivered to SECURITRON's facility (freight and insurance charges prepaid by customer). The replacement, at SECURITRON's sole option, may be the identical item or a newer unit which serves as a functional replacement. In the event that the product type has become obsolete in SECURITRON's product line, this MAGNACARE warranty will not apply. This MAGNACARE warranty also does not apply to custom, built to order, or non-catalog items, items made by others (such as batteries), returns for payment, distributor stock reductions, returns seeking replacement with anything other than the identical product, or products installed outside of the United States or Canada. This MAGNACARE warranty also does not apply to removal or installation costs.

SECURITRON will not be liable to the purchaser, the customer or anyone else for incidental or consequential damages arising from any defect in, or malfunction of, its products. SECURITRON does not assume any responsibility for damage or injury to person or property due to improper care, storage, handling, abuse, misuse, or an act of God.

EXCEPT AS STATED ABOVE, SECURITRON MAKES NO WARRANTIES, EITHER EXPRESS OR IMPLIED, AS TO ANY MATTER WHATSOEVER, INCLUDING WITHOUT LIMITATION THE CONDITION OF ITS PRODUCTS, THEIR MERCHANTABILITY OR FITNESS FOR ANY PARTICULAR PURPOSE.

APPENDIX A: TROUBLESHOOTING

PROBLEM-- Unit will not operate when trigger wire is connected to +V.

On a new installation, make sure that DC power (12 or 24 volts depending on the model) is connected to the red and black wires with correct polarity. When this is confirmed note that the UnLatch will never operate unless the springlatch plunger is pushed in by the springlatch (see Section 3.3). You can be “fooled” by this feature if you’re trying to test operate the UnLatch with the door open. To do this, use a pencil or other similar object to lightly push in the springlatch plunger and then close the trigger wire to +V and you will see the UnLatch plungers move.

On a service call for a unit with successful operating history, in addition to the checks mentioned above, check to see if the door and latch have gotten into a warped situation where there is heavy pre-loading on the door. The UnLatch’s motor may not be able to release the latch under this condition but you should be able to hear it trying to release the latch. The UnLatch will automatically shut down its motor if it can’t release the latch within 1.5 seconds. It will operate normally when it is re-triggered. You should be able to try operation by removing the pre-loading by pushing the door closed with enough force to counteract the pre-loading. Note that this situation is more likely if power supply capacity is less than 3 Amps (see Section 3.1). Corrections for this type of warped door situation is to have the door serviced and possibly increase the capacity of the power supply.

If the unit still will not function, note that it does have an internal microprocessor that could have gotten into a crash condition. This can happen some times if the unit is under-powered (see Section 3.1) and has consequently stalled (the motor is not receiving enough power to operate the latch). While the motor is in the process of stalling, voltage to the processor will sharply drop and this can crash the microprocessor. A crash can also occur as a random event but this is unusual. The **recovery technique** is to de-power the unit, and then re-power it **with the red and orange wires already connected** (both then connect to +V). This re-initializes the firmware. Naturally, once this operation has been performed, return the unit to standard wiring (orange only connects to +V to trigger the unit.)

Finally, the unit could have experienced motor failure or other internal electronic failure. It is repairable by the factory.

PROBLEM -- Unit will occasionally not operate.

Generally, this comes from too much door pre-loading possibly coupled with a low capacity power source. When the UnLatch can’t generate enough torque to release the latch, it automatically shuts down but then operates the next time it is triggered. See the previous paragraph.

PROBLEM -- Latch does not re-secure when the door re-closes.

This is not a problem with the UnLatch but is rather a problem with the installation. The latch is simply not moving into position. Make sure the door closer is properly operating to re-close the door with reasonable force. Next, re-read Section 2.5 to make sure the UnLatch is in the correct position with respect to the door stop.

PROBLEM -- Latch status sensing does not function.

The latch status output contacts (see Section 3.3) will change state when the springlatch plunger is pushed in. To check this, therefore, push the springlatch plunger lightly in with a pencil or other similar object. Make sure the unit is receiving power when you make this check or the output contacts will not switch. If they still do not switch, the unit will need to be returned to the factory for repair.

PATENTS

The UnLatch is covered under U.S. patents #5,474,342 and #6,022,056 with other US and international patents pending.

TEMPLATE FOR CUTTING OUT ANSI 2 3/4" STRIKE PREPARATION AND INSTALLING UNLATCH ON WOODEN FRAME

